

Operator's Manual

optris[®] PI LightWeight kit

IR camera with Recording box for
flight applications



Optris GmbH

Ferdinand-Buisson-Str. 14
D – 13127 Berlin
Germany

Tel.: +49 30 500 197-0
Fax: +49 30 500 197-10

E-mail: info@optris.de
Internet: www.optris.com



Table of contents

1	General notes	8
1.1	Intended use	8
1.2	Warranty	10
1.3	Scope of delivery	11
1.4	Maintenance	12
1.4.1	Cleaning.....	12
2	Technical Data.....	13
2.1	Recording box.....	13
2.1.1	General specifications	13
2.1.2	Electrical specifications.....	14
2.2	Camera PI 400 / PI 450 / PI640 LW	15
2.2.1	General specifications	15

2.2.2	Electrical specifications.....	19
2.2.3	Measurement specifications	19
2.2.4	Optical specifications	21
3	Installation.....	26
3.1	Physical installation	26
3.2	Mechanical Data PI 400/ PI 450 / PI 640 LW	27
3.3	Dimensions Recording box.....	28
3.4	Functional interfaces Recording box	29
3.5	Recording box operating modes.....	32
3.5.1	Configuration for PI on HDMI output	33
3.5.2	Configuration for PI on analog TV output	33
3.5.3	Configuration for PI + GoPro on TV output	33

3.5.4	Configuration for PI on HDMI output + GoPro on TV output	34
4	Operation	35
4.1	Startup of the Recording box	35
4.2	Stand-Alone operation	36
4.3	Multifunction button.....	37
4.4	Start a recording	38
4.4.1	Recording control with an electrical switch	38
4.4.2	Recording control with the Recording box multifunction button	39
4.4.3	Recording control with a servo control	40
4.4.4	Recording control via screw terminal block	40
4.4.5	Recording time duration.....	41
4.4.6	Record Storage.....	41

4.5	Operation Display	44
4.6	Analyzing of radiometric videos on a PC	46
4.7	Recording box configuration	49
4.8	GoPro Camera.....	52
4.9	Using a GPS	54
4.10	Micro SD card	57
4.11	LED indicators	58
4.12	Using servo control	59
4.12.1	Servo connector wiring	59
4.13	Screw connectors interface	60
5	System Update and Recovery	62
5.1	System updates	62

5.2	Recorder Software Update	63
5.3	System Recovery.....	64
6	Calibration files and Time settings.....	65
6.1	Installing the calibration files through Internet	65
6.2	Installing the calibration files with an USB flash memory	65
6.3	Time settings	67
7	Backup battery replacement.....	68
8	Basics of Infrared Thermometry	69
9	CE Conformity	77

1 General notes

1.1 Intended use

The optris PI LightWeight kit consists of a miniaturized lightweight Linux computer (Recording box) and a weight-optimized PI400 LW, PI450 LW or PI640 LW infrared camera. The system is ideally suited for UAV based radiometric infrared recordings. It can be used for applications like maintenance work and quality inspections of solar and wind power systems and for building thermography.

The Recording box works with a Linux operating system that allows on-flight recording of infrared videos with the maximum speed of the camera.

The optris PI 400 LW, 450 LW or 640 LW measures the surface temperature based on the emitted infrared energy of objects [**► Basics of Infrared Thermometry**]. The two-dimensional detector (FPA - focal plane array) allows a measurement of an area which will be shown as thermal image using standardized color palettes. The radiometric processing of the picture data enables the user to do a comfortable detailed analysis with the software PI Connect retrospectively.



The PI is a precise instrument and contains a sensitive infrared detector and a high-quality lens.

The alignment of the camera to intensive energy sources (e.g. devices which emit laser radiation or reflections of such equipment) can cause an irreparable defect of the infrared detector. This is also valid if the camera is switched off.

Such kinds of damages are excluded from warranty.



- Avoid static electricity, arc welders, and induction heaters. Keep away from very strong EMF (electromagnetic fields).
- Avoid abrupt changes of the ambient temperature.
- In case of problems or questions which may arise when you use the infrared camera contact our service department.



Read the manual carefully before the initial start-up. The producer reserves the right to change the herein described specifications in case of technical advance of the product.

1.2 Warranty

Each single product passes through a quality process. Nevertheless, if failures occur contact the customer service at once. The warranty period covers 24 months starting on the delivery date. After the warranty is expired the manufacturer guarantees additional 6 months warranty for all repaired or substituted product components. Warranty does not apply to damages, which result from misuse or neglect. The warranty also expires if you open the product. The manufacturer is not liable for consequential damage or in case of a non-intended use of the product.

If a failure occurs during the warranty period the product will be replaced, calibrated or repaired without further charges. The freight costs will be paid by the sender. The manufacturer reserves the right to exchange components of the product instead of repairing it. If the failure results from misuse or neglect the user has to pay for the repair. In that case you may ask for a cost estimate beforehand.

1.3 Scope of delivery

- IR camera PI400 LW or PI450 LW or PI640 LW (LightWeight) with one lens and fixed mounted USB cable (40 cm)
- Recording box (Linux computer)
- Power supply (100-240 VAC / 24 VDC)
- Power cable (with open ends)
- Video cable bridge (HDMI to micro-HDMI, 16 cm)
- USB 2.0 cable bridge (USB to mini-USB, 15 cm)
- Special USB+video cable for GoPro camera (mini-USB to mini-USB, 30 cm)
- Video cable (stereo mini jack-open ends) including external recording pin
- 128 GB high speed USB 3.0 memory stick
- 16 GB micro SDHC memory card
- CD-ROM including PIconnect software, camera calibration files, documentation
- Rugged outdoor case, IP67
- Operators manual

1.4 Maintenance



Never use cleaning compounds which contain solvents (neither for the lens nor for the housing).



Take care that no foreign substances penetrate into the venting slots of the Recording box.

1.4.1 Cleaning

The housing of the Recording box can be cleaned with a soft, humid tissue moistened with water or a water based cleaner.

Blow off loose particles using clean compressed air. The lens surface can be cleaned with a soft, humid tissue moistened with water or a water based glass cleaner.

2 Technical Data

2.1 Recording box

2.1.1 General specifications

Operating temperature:	0...50 °C
Storage temperature:	-20...75 °C
Relative humidity:	10...95 %, non-condensing
Material (housing):	aluminum
Dimensions:	96 mm x 67 mm x 47 mm (L x W x H)
Weight:	172 g (without the four mounting bricks)
Vibration:	IEC 60068-2-6 (sinus shaped), IEC 60068-2-64 (broad band noise)
Shock:	IEC 60068-2-27 (25 g and 50 g)
Operating system	Linux Ubuntu 14.04 LTS

2.1.2 Electrical specifications

Power supply:	10 to 48 VDC
Power consumption:	12 W
Cooling:	active via integrated temperature controlled fan
Module:	ODROID-XU4
Processor:	Samsung Exynos5422 (Cortex™ A15 2GHz and Cortex™ A7) Octa core
Memory:	8 GB eMMC flash storage/ 16 GB Micro-SDHC card (not intended to be exchanged by user)
RAM:	2 GB LPDDR3 RAM
Ports:	2 x USB 3.0; 1 x USB 2.0; 1 x Mini-USB for a GoPro Hero 3+ and higher; RJ45 Ethernet (Gigabit Ethernet)
	HDMI 1.4a or Mini jack 2.5 mm Video composite (CVBS) NTSC TV _{out} ; 2 x Servo-connector (Uni, Graupner /JR); 2 x 4-screw terminal
Additional functions	5 x Status-LED; Function button

2.2 Camera PI 400 / PI 450 / PI640 LW

2.2.1 General specifications

Environmental rating:	IP40
Ambient temperature:	0...50 °C [PI 400 LW & PI640 LW] / 0...70 °C [PI 450 LW]
Storage temperature:	-40...70 °C [PI 400 LW & PI640 LW]] / -40...85 °C [PI 450 LW]
Relative humidity:	10...95 %, non-condensing
Material (housing):	aluminum, anodized/ plastic
Dimensions:	46 x 56 x 84 - 88 mm (depending on lens)
Weight (incl. lens):	207 g
Cable length (USB 2.0):	40 cm
Vibration ¹⁾ :	IEC 60068-2-6 (sinus shaped) IEC 60068-2-64 (broad band noise)
Shock ¹⁾ :	IEC 60068-2-27 (25 g and 50 g)

¹⁾ **Used standards:**

IEC 60068-1:1988 + Corr. 1988 + A1: 1992	DIN EN 60068-1:1995-03
„Umweltprüfungen - Teil 1: Allgemeines und Leitfaden“	
IEC 60068-2-6:2007	DIN EN 60068-2-6; VDE 0468-2-6:2008-10
„Umgebungseinflüsse - Teil 2-6: Prüfverfahren - Prüfung Fc: Schwingen (sinusförmig)“	
IEC 60068-2-27:2008	DIN EN 60068-2-27; VDE 0468-2-27:2010-02
„Umgebungseinflüsse - Teil 2-27: Prüfverfahren - Prüfung Ea und Leitfaden: Schocken“	
IEC 60068-2-47:2005	DIN EN 60068-2-47:2006-03
„Umgebungseinflüsse - Teil 2-47: Prüfverfahren - Befestigung von Prüflingen für Schwing-, Stoß- und ähnliche dynamische Prüfungen“	
IEC 60068-2-64:2008	DIN EN 60068-2-64; VDE 0468-2-64:2009-04
„Umgebungseinflüsse - Teil 2-64: Prüfverfahren - Prüfung Fh: Schwingen, Breitbandrauschen (digital geregelt) und Leitfaden“	

Figure 1: Used standards

Stress program (camera in operation):

Shock, half sinus 25 g – testing Ea 25 g (acc. IEC 60068-2-27)			
Acceleration	245 m/s ²	(25 g)	
Pulse duration	11 ms		
Number of directions	6	(3 axes with 2 directions each)	
Duration	600 Shocks	(100 Shocks each direction)	
Shock, half sinus 50 g – testing Ea 50 g (acc. IEC 60068-2-27)			
Acceleration	490 m/s ²	(50 g)	
Pulse duration	11 ms		
Number of directions	6	(3 axes with two directions each)	
Duration	18 Shocks	(3 Shocks each direction)	

Vibration, sinus shaped – testing Fc (acc. IEC60068-2-6)

Frequency range	10-500 Hz		
Acceleration	29.42 m/s ²	(3 g)	
Frequency change	1 Octave/ min		
Number of axes	3		
Duration	1:30 h	(3 x 0.30 h)	

Vibration, broadband noise – testing Fh (acc. IEC60068-2-64)

Frequency range	10-2000 Hz		
Acceleration	39.3 m/s ²	(4,01 g _{RMS})	
Frequency spectrum	10-106 Hz	0,9610 (m/s ²) ² /Hz	(0,010 g ² /Hz)
	106-150 Hz	+6 dB/ Octave	
	150-500 Hz	1,9230 (m/s ²) ² /Hz	(0,020 g ² /Hz)

	500-2000 Hz	-6 dB/ Octave	
	2000 Hz	0,1245 (m/s ²) ² /Hz	(0,00126 g ² /Hz)
Number of axes	3		
Duration	3 h	(3 x 1 h)	

2.2.2 Electrical specifications

Power Supply:	5 VDC (powered via USB 2.0 interface)
Current draw:	Max 500 mA
Digital interface:	USB 2.0

2.2.3 Measurement specifications

Temperature ranges:	-20...100 °C; 0...250 °C; 150...900 °C
---------------------	--

Detector:	UFPA, 382 x 288 pixels (PI4xx) / 640 x 480 pixels (PI640)
Spectral range:	7.5...13 μm
Lenses (FOV):	13° x 10°; 29° x 22°, 38° x 29°; 53° x 40°, 62° x 49°; 80° x 58° [PI4xx] 15° x 11°; 33° x 25°; 60° x 45°; 90° x 66° [PI640]
System accuracy ¹⁾ :	$\pm 2^\circ\text{C}$ or $\pm 2\%$
Temperature resolution (NETD):	PI 400 LW ²⁾ : 0.08 K
	P I450 LW ²⁾ : 0.04 K
	PI640 LW ³⁾ : 0.075 K
Frame rate:	27 & 80 Hz (PI4xx) / 32 Hz (PI640) / 125 Hz (PI640 in VGA sub-frame mode)

¹⁾ At ambient temperature $23 \pm 5^\circ\text{C}$; whichever is greater; ²⁾ Value is valid at 40 Hz and 25°C object temperature, ³⁾ Value is valid at 32 Hz and 25°C object temperature

2.2.4 Optical specifications



Make sure that the focus of the infrared camera is adjusted correctly. For focusing turn the lens.



Figure 2: Focusing of the lens (1 – lens)

PI 400 / 450 382 x 288 px	Focal length [mm]	Angle	Minimum measurement distance*	Distance to measurement object [m]												
					0.02	0.1	0.2	0.3	0.5	1	2	4	6	10	30	100
O38 Standard lens	15	38°	0.2 m	HFOV [m]	0.024	0.079	0.15	0.21	0.35	0.70	1.39	2.76	4.14	6.9	20.7	68.9
		29°		VFOV [m]	0.018	0.060	0.11	0.16	0.26	0.52	1.04	2.07	3.11	5.2	15.5	51.7
		49°		DFOV [m]	0.030	0.099	0.18	0.27	0.44	0.87	1.73	3.46	5.18	8.6	25.9	86.2
		1.81 mrad		IFOV [mm]	0.1	0.2	0.4	0.5	0.9	1.7	3.4	6.7	10.0	16.7	50.0	166.7
O13 Telephoto lens	41	13°	0.5 m	HFOV [m]					0.12	0.23	0.47	0.94	1.40	2.3	7.0	23.4
		10°		VFOV [m]					0.09	0.17	0.35	0.70	1.05	1.7	5.2	17.5
		17°		DFOV [m]					0.15	0.29	0.58	1.17	1.75	2.9	8.8	29.2
		0.61 mrad		IFOV [mm]					0.3	0.6	1.2	2.5	3.7	6.1	18.4	61.2
O62 Wide angle lens	11	62°	0.5 m	HFOV [m]	0.040	0.136	0.26	0.38	0.62	1.22	2.42	4.83	7.23	12.0	36.1	120.3
		49°		VFOV [m]	0.030	0.103	0.19	0.28	0.47	0.92	1.83	3.65	5.47	9.1	27.3	90.9
		74°		DFOV [m]	0.050	0.170	0.32	0.47	0.77	1.53	3.03	6.05	9.06	15.1	45.2	150.8
		3.14 mrad		IFOV [mm]	0.1	0.2	0.5	0.7	1.2	2.29	4.56	9.11	13.65	22.7	68.2	227.3
O80 Wide angle lens	7,7	80°	0.2 m	HFOV [m]		0.182	0.35	0.84	0.84	1.65	3.29	6.55	9.82	16.4	49.0	163.4
		56°		VFOV [m]		0.119	0.23	0.55	0.54	1.08	2.14	4.28	6.41	10.7	32.0	106.6
		97°		DFOV [m]		0.218	0.41	1.00	1.00	1.97	3.92	7.83	11.73	19.5	58.5	195.1
		3.25 mrad		IFOV [mm]		0.3	0.7	1.6	1.6	3.3	6.5	13.0	19.5	32.5	97.4	324.7

Table with examples showing which measurement field sizes and pixel sizes will be reached at which distance. For optimal configuration of the camera there are various lenses available. Wide angle lenses have radial distortion due to the angle of their aperture. The PI Connect software has an algorithm which corrects this distortion.

* Please note: The measurement accuracy of the camera may lie outside of the specifications for distances below the defined minimum measurement distance.

PI 640 640 x 480 px	Focal length [mm]	Angle	Minimum measurement distance*	Distance to measurement object [m]											
					0.1	0.2	0.3	0.5	1	2	4	6	10	30	100
O33 Standard lens	18.7	33°	0.2 m	HFOV [m]	0.068	0.13	0.19	0.31	0.60	1.20	2.38	3.57	5.9	17.8	59.3
		25°		VFOV [m]	0.051	0.09	0.14	0.23	0.45	0.89	1.77	2.65	4.4	13.2	44.2
		41°		DFOV [m]	0.085	0.16	0.23	0.38	0.75	1.49	2.97	4.45	7.4	22.2	74.0
		0.91 mrad		IFOV [mm]	0.1	0.2	0.3	0.5	0.9	1.8	3.6	5.5	9.1	27.3	90.9
O15 Tele lens	41,5	15°	0,5 m	HFOV [m]				0.13	0.26	0.52	1.05	1.57	2.6	7.8	26.1
		11°		VFOV [m]				0.10	0.20	0.39	0.79	1.18	2.0	5.9	19.6
		19°		DFOV [m]				0.17	0.33	0.66	1.31	1.96	3.3	9.8	32.7
		0.41 mrad		IFOV [mm]				0.2	0.4	0.8	1.6	2.5	4.1	12.3	41.0
O60 Wide angle lens	10.5	60°	0.2 m	HFOV [m]	0.128	0.25	0.36	0.59	1.17	2.32	4.63	6.94	11.6	34.6	115.4
		45°		VFOV [m]	0.091	0.18	0.26	0.42	0.83	1.66	3.31	4.96	8.3	24.7	82.4
		75°		DFOV [m]	0.157	0.30	0.44	0.72	1.43	2.85	5.69	8.52	14.2	42.6	141.8
		1.62 mrad		IFOV [mm]	0.2	0.3	0.5	0.8	1.6	3.2	6.5	9.7	16.2	48.6	161.9
O90 Super wide angle lens	7.7	90°	0.2 m	HFOV [m]	0.220	0.43	0.63	1.03	2.03	4.04	8.06	12.07	20.1	60.3	200.8
		64°		VFOV [m]	0.138	0.27	0.39	0.64	1.27	2.53	5.05	7.57	12.6	37.8	125.9
		111°		DFOV [m]	0.260	0.50	0.73	1.21	2.39	4.76	9.50	14.24	23.7	71.1	237.0
		2.21 mrad		IFOV [mm]	0.2	0.4	0.7	1.1	2.2	4.4	8.8	13.2	22.1	66.2	220.8

Table with examples showing which measurement field sizes and pixel sizes will be reached at which distance. For optimal configuration of the camera there are various lenses available. Wide angle lenses have radial distortion due to the angle of their aperture. The PI Connect software has an algorithm which corrects this distortion.

* Please note: The measurement accuracy of the camera may lie outside of the specifications for distances below the defined minimum measurement distance.

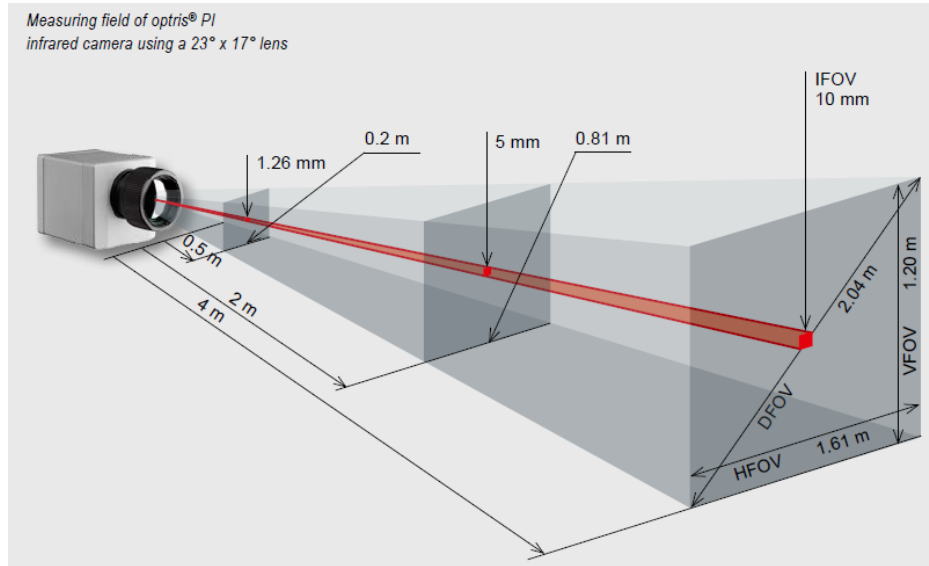

Figure 3: Example of measurement field of the infrared camera PI160 representing the 23° x 17° lens

- **HFOV:** Horizontal enlargement of the total measuring at object level
- **VFOV:** Vertical enlargement of the total measuring at object level
- **IFOV:** Size at the single pixel at object level
- **DFOV:** Diagonal dimension of the total measuring field at object level
- **MFOV:** Recommended, smallest measured object size of 3 x 3 pixel

3 Installation

3.1 Physical installation

The PI 400 LW/ 450 LW / 640 LW are equipped with two metric M4 thread holes on the bottom side (6 mm depth) and can be installed either directly via these threads or with the ¼" photo tripod mount (also on bottom side). The separate PI camera sensing head can be mounted on the stabilization platform of a drone together with a visual camera (in the picture: GoPro camera). The Recording box can be mounted separately in different directions using the supplied and pre-assembled mounting bricks.

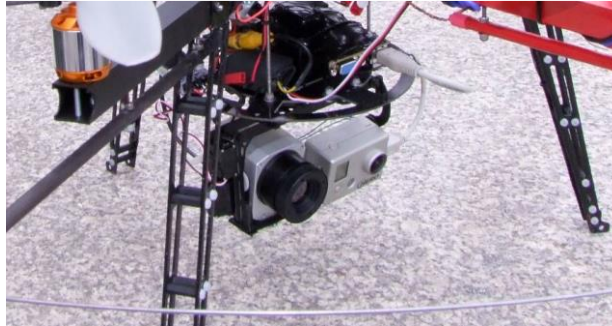

Figure 4: PI LightWeight on a drone together with a GoPro HD camera

3.2 Mechanical Data PI 400/ PI 450 / PI 640 LW

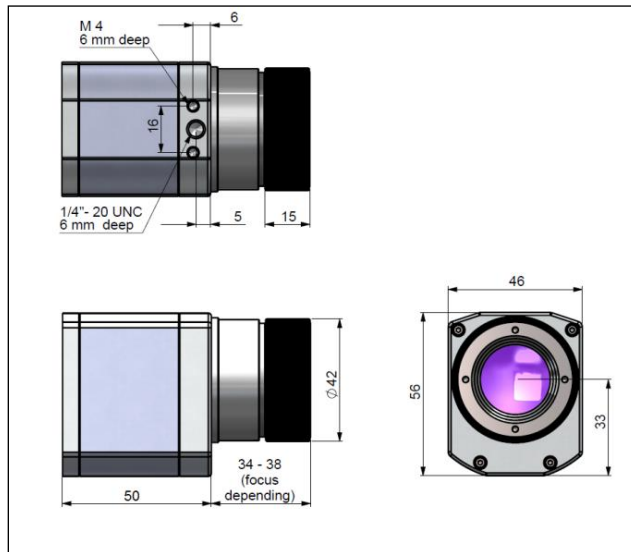

Figure 5: Dimensions PI400/ PI450 / PI640 LW (mm)

3.3 Dimensions Recording box

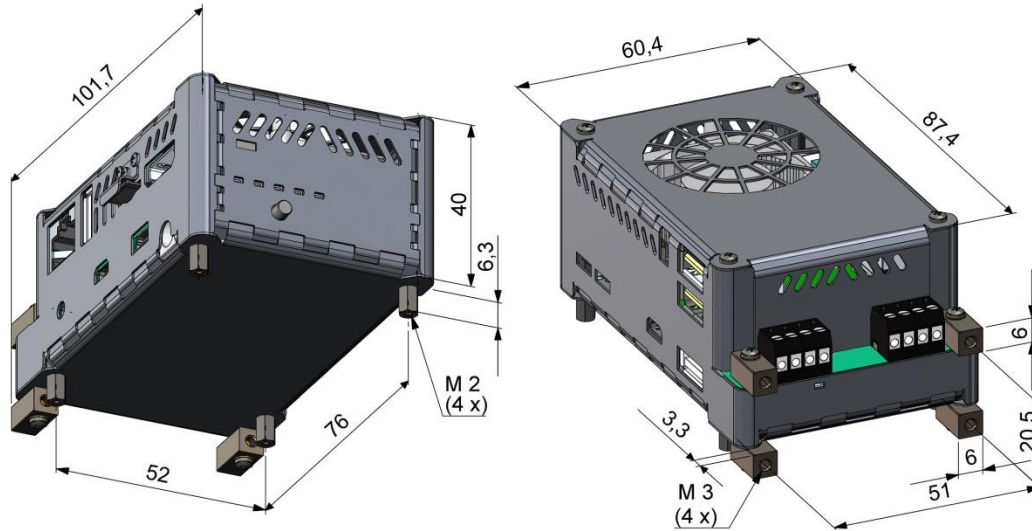

Figure 6: Dimensions Recording box (mm)

3.4 Functional interfaces Recording box

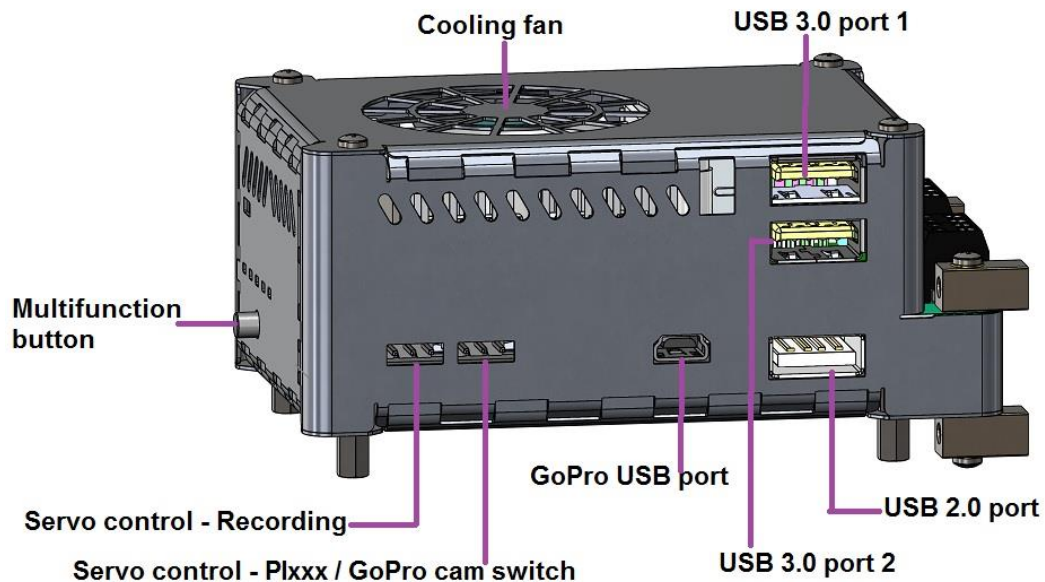

Figure 7: Controls and connections Recording box (1)

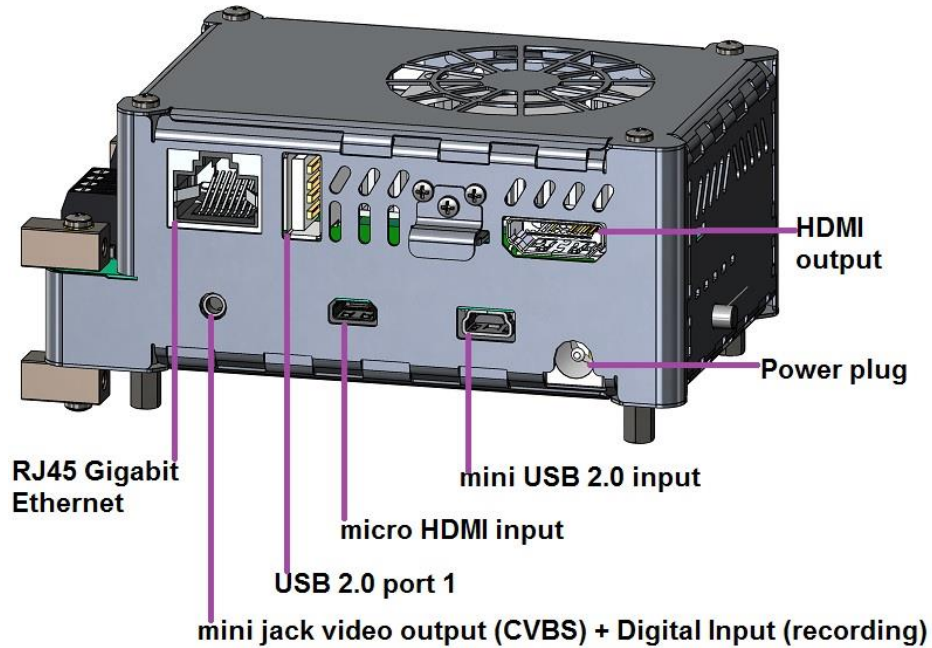

Figure 8: Controls and connections Recording box (2)

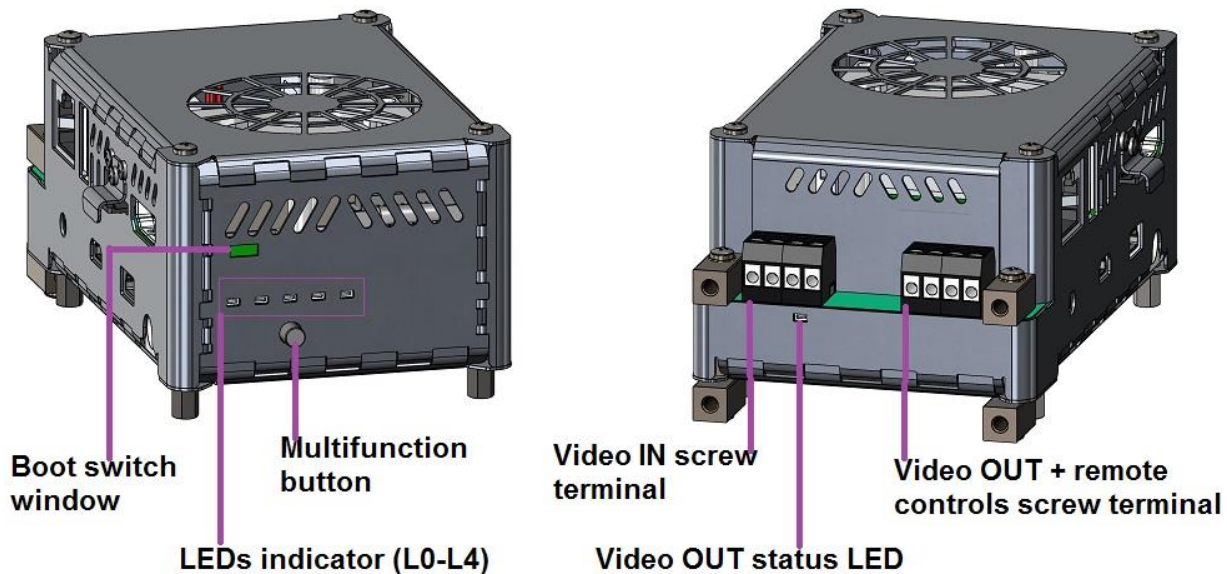

Figure 9: Controls and connections Recording box (3)

3.5 Recording box operating modes

The PI LightWeight Recording box features a modular conception which provides the possibility to use different configurations:

- Infrared PI camera on HDMI video output only
- Infrared PI camera on analog CVBS TV output only
- Infrared PI camera and visible GoPro Hero3+ (and above) camera, on analog CVBS TV output, switched by button on screw terminal, or remote control
- Infrared PI camera on HDMI video output and GoPro camera on analog CVBS TV output, simultaneously

The use of an external GPS USB stick is optional. If it is connected to an USB 2.0 port, geo data will be recorded in IR video file.

In addition the recording can be remotely controlled by servo commands or by a switch (screw terminal).

3.5.1 Configuration for PI on HDMI output

Connect the PI imager to one of the USB3.0 interfaces. The GPS-Stick (U-Blox) can be connected with the USB2.0 interface whereas the HDMI interface is used as video output.

3.5.2 Configuration for PI on analog TV output

The HDMI video output is forwarded to the micro HDMI by using the HDMI cable bridge (see Figure 9: Controls and connections Recording box (3)).

The infrared image is available on the mini jack CVBS TV output between the thick black wire and the red wire of the cable provided (see chapter 0)

Connect the PI to an USB 3.0 port (blue), the U-Blox USB GPS to the USB 2.0 port (optionally).

3.5.3 Configuration for PI + GoPro on TV output

Connect the HDMI output to the micro HDMI input with the provided cable bridge, connect the USB 2.0 port (1) to the mini USB 2.0 port input with the provided cable bridge (see Figure 9: Controls and connections Recording box (3))

Connect the PI to an USB 3.0 port (blue), the GoPro Hero 3+ to the GoPro USB port (see Figure 7: Controls and connections Recording box (1)), and the U-Blox USB GPS to an USB 2.0 port (optionally).

This configuration offers the possibility to switch between infrared and visible image. The video signal can be acquired from the mini jack port (see chapter 0).

3.5.4 Configuration for PI on HDMI output + GoPro on TV output

It is possible to have both images (IR & visible) simultaneously on the two video outputs:

- The infrared image is permanently available on the HDMI output
- The visible image is permanently available on the TV output (mini jack)

Connect the PIxxx to an USB 3.0 port (blue), the GoPro Hero 3+ to the GoPro USB port (see Figure 7: Controls and connections Recording box (1)), and the U-Blox USB GPS to an USB 2.0 port (optionally).

Connect the USB 2.0 port (1) to the mini USB 2.0 port input with the provided cable bridge (see Figure 9: Controls and connections Recording box (3)).

4 Operation

4.1 Startup of the Recording box

To startup PI LightWeight, connect all the cables according to the desired operating mode and simply plug the provided power cable (powered from power supply or LiPo battery), there is no ON/OFF switch.



Before to power on the Recording box, the **HDMI output must be connected** either to the Micro-HDMI socket, or to a powered monitor to ensure a correct **initialization of the video output**.

To power off the system please disconnect the power cable (no need to connect a keyboard to properly shutdown).



If an Ethernet connection is active with internet access at startup, the system will be set to the current time and date, and if necessary the calibration files will be downloaded from the internet.

4.2 Stand-Alone operation



For a self-contained power supply, a lithium-polymer battery with a voltage from 11 to 25 VDC (LiPo 3S to LiPo 6S) is recommended.

After powering the Recording box, the system boots and is ready in about 30 seconds. A video monitor connected to the system via the video adapter cable, shows the IR live picture of the camera in full screen mode.



Please note that even if the IR video is displayed as soon as the system starts, a good image and reliable temperature measurement will be possible only after a while, especially in cold environment (up to 10 minutes at 0 °C ambient temperature).

4.3 Multifunction button

The multifunction button (see Figure 9: Controls and connections Recording box (3)) has the following functions:

Context	Function
Recording box is running.	Press > 5s => shutdown the system
Recording box is running with IR image visible.	Press for 1 s => start/ stop recording
Recording box is unpowered.	Power the box. Keep pressing the button until the Recording box is ready to operate and the thermal image is visible on screen: => internal memory gets cleared
Recording box is powered. Records have been made directly on USB drive by using the external switch, e.g. during flight.	Press for 1 s => GoPro data is copied to attached USB drive.



- A short press < 1 s can have no effect
- 1 s press functions are also duplicated by the servo control (left connector) and remote control contact (mini jack and screw connector)

4.4 Start a recording

There are four possibilities to start a recording:

- Using an electrical contact (open/ close) via the analog video cable
- Using the Recording box multifunction button
- Using a servo control (Uni, Graupner /JR) or
- Using a switch on the screw terminal

4.4.1 Recording control with an electrical switch

To start the recording remotely by an electrical contact, connect the supplied video cable (**Order No.: ACPILKVCB2**), see **Figure 10** left, to the mini jack video output:

black (thick)	GND (common GND for trigger and video)
black (thin)	Recording trigger
red	Video signal (TV output: NTSC CVBS)

The recording starts if the trigger is connected to GND during one second, and stops doing the same again.



Figure 10: Video cable (Order No.: ACPIKVCB2) left, and video cable (Order No.: ACPIKVCB2C) right

The second video cable (**not supplied** - Order No.: ACPIKVCB2C) can be used for a direct connection of the system to a monitor – the recording can be started by the micro switch.

4.4.2 Recording control with the Recording box multifunction button

The Recording box button is a multi-purpose command button. If the imager is active the pressing of this button for at least one second starts a recording, and during a recording session pressing it for at least one second stops the recording.

4.4.3 Recording control with a servo control

By connecting a servo control (Uni, Graupner /JR, type) to the Recording box servo control input, it is possible to start and stop the recording via remote control.

4.4.4 Recording control via screw terminal block

The external switch S2 of the right screw terminal is Low-active and must be connected to ground (a simple switch to ground is recommended) to start a recording (see 4.13). After disconnecting from ground the recording will stop.

4.4.5 Recording time duration

The maximum recording time depends on the camera and video mode (frame frequency). It is recommended to record directly on external memory (Firmware \geq v1.1.3.0) as it avoids a copy process after recording. The given example refers to a 128 GB USB 3.0 Drive

PI640 LW	32 Hz ~ 108 minutes (640 x 480 pixels)
PI640 LW	125 Hz ~ 108 minutes (640 x 120 pixels)
PI4xx LW	27 Hz ~ 356 minutes
PI4xx LW	80 Hz ~ 120 minutes



The remaining recording time and space on the USB-drive or the internal memory is displayed during the recording.

4.4.6 Record Storage

Directly on USB stick

By default an external memory (USB-drive) with 128 GB capacity is provided. For storing records on this stick, plug into one of the USB 3.0 ports. To check if the stick is available, the display message “**USB Stick attached**” should appear.

On internal memory

If the external memory is not connected the internal memory will be used automatically. After finishing the recording the data can be copied to an USB stick.

If the USB stick is well detected by the system it displays “**Mounting USB stick**”. If there is at least one record to copy the data transfer to the USB stick starts. A progress bar shows the downloading percentage “**Writing (progress: xx.xx%)**”. In case you are using a GoPro camera and if on the GoPro are videos available they are also downloaded to the stick automatically at the end. The message “**Synchronizing GoPro**” appears.

After that the download is finished (duration time depending of the speed capability of the USB stick and of the size of the files to download) the system displays “**USB stick attached**”. It is then possible to withdraw the USB stick safely.





The USB 3.0 drive should feature a writing speed of at least 10 MByte/ s for PI4xx (27Hz) and 25 MByte/ s for PI4xx (80Hz)/ PI640 (32Hz). The internal SD card can only be used for recordings with a PI4xx (27Hz).

USB 2.0 drives are supported for copying data, not for recording data.

The recording box is optimized to work with USB drives with FAT32 file system.

Reassure the stick is formatted with FAT32 file system.

USB drives larger than 32 GB cannot be formatted with Windows OS, but with extra tools like "[HP USB Disk Storage Format Tool](#)".

4.5 Operation Display

The video output of the Recording box shows a live stream of the thermal imager. The temperatures are indicated by a color palette. The color palette can be altered by the user (see section 4.7).

By default, a hot spot (red), cold spot (blue) and center spot (white) is displayed with temperature information for supporting the drone pilot.

In addition, a notification area is displayed at the bottom of the screen providing user information. The notification area provides information about user interaction, which is indicated as follows:

- activating of external switches: Information to initiated actions is displayed (recording start e.g.)
- plug in an USB memory drive: Information that stick is plugged is displayed
- plug in a GPS-dongle: GPS coordinates are shown, if stick is initialized
- plug in a GoPro camera: Visible video mode is available via analogue video output and can be toggled with thermal image
- plug in an Ethernet cable: indicator for time synchronization and check for calibration files

If no imager is connected or if the calibration files are missing, the Recording box is waiting and displays the start screen which provides information about the installed firmware version.



Figure 11: Display if no imager is connected or calibration files missing

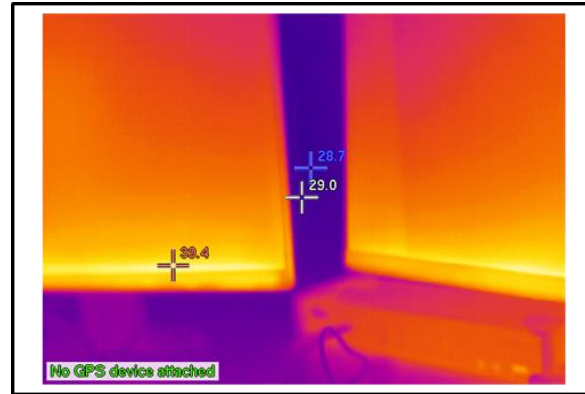

Figure 12: Display, if imager is connected

4.6 Analyzing of radiometric videos on a PC

The recorded files contain raw thermal IR energy data and geo data which needs to be converted. Extension of these files is *.raw and they have to be first converted by PIConnect software to the *.ravi format to enable further analysis in PIConnect.

The raw file naming conventions is defined as follows:

ir_XXXXXXXX_YYMMDD_HHMMSS.raw

XXXXXXXX	Serial number of the PI camera
YYMMDD	Date of recording
HHMMSS	Time of recording

In PIConnect software, select in the menu: “File/ Open” and then “Radiometric raw data files” as file type.

Select the raw file you want to use. Depending on the length of the recording it is possible that the raw file is split into several sub files with the same file name but different extensions (raw.1, raw.2, raw.3, ...). Only the main file is displayed and needs to be selected.

Then you get a message window:

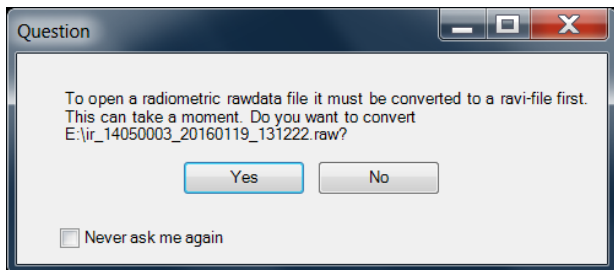

Validate, and there is the conversion window displayed:

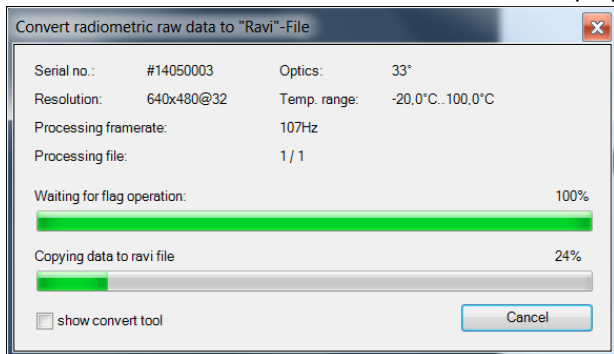

The conversion needs to be finalized by providing a file name of the converted RAW file. The record file is automatically played by the imager software:

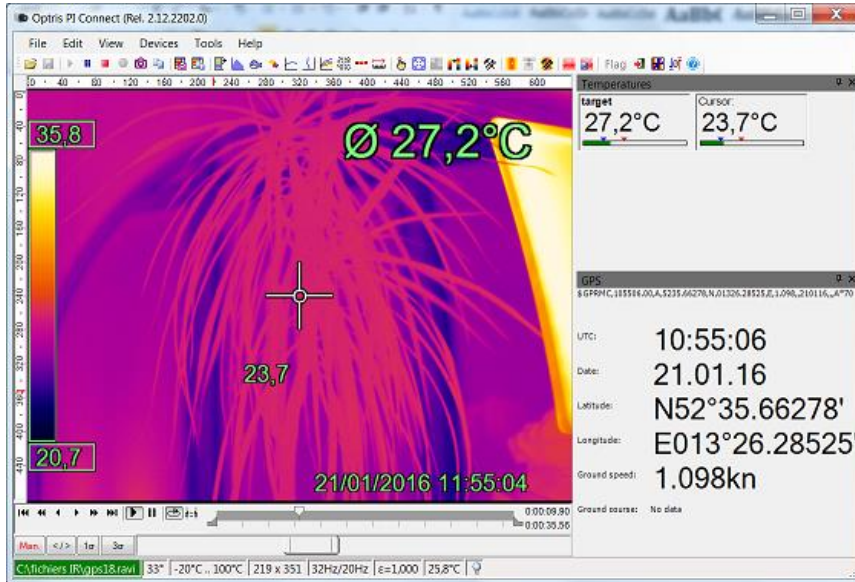

Figure 113: Screenshot of PIConnect displaying the GPS data embedded in radiometric file.

4.7 Recording box configuration

There are different parameters of the Recording box which can be adjusted by the user. The recording box can operate different imagers (only one at the same time). Each imager can be configured individually:

- Recording speed (27 or 80 Hz for a PI4xx camera; 32 or 125 Hz for a PI640)
- Measuring temperature range (-20 to 100 °C or 0 to 250 °C or 150 to 900 °C)
- Lens in use (only if this PI camera has been calibrated with more than one lens)
- Color palette
- Flag properties
- Image contrast

The default configuration is 27 Hz for PI4xx and 32 Hz for PI640; the standard temperature range is -20 to 100 °C.

To change the Recording box parameters you first have to generate a configuration file in PIconnect software. This file has to be loaded then into the Recording box.

- 1) Connect the PI camera to the PC where PIconnect software is installed,
- 2) If the imager is connected the first time to this PC it is necessary to load the calibration files from the internet,
- 3) Adjust the configuration in PIconnect as desired,
- 4) Export a configuration file to an USB stick: Open the PIconnect menu "**Tools/ Extended/ Config Recording box**". It is possible to send the calibration files also to the Recording box, if they are not present there. Select the USB flash memory where you want to copy these files:

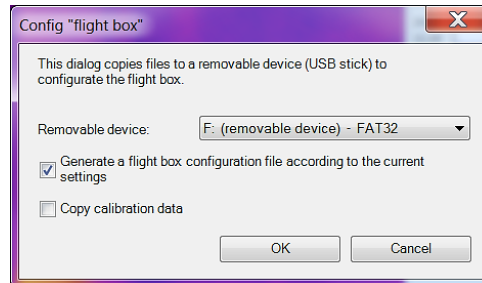

- 5) Connect the PI camera and the USB stick to an USB 3.0 USB port of the Recording box, the configuration file is automatically loaded to set the parameters.



For generating the Recording box configuration file it is required to connect the imager to a PC where PIConnect is installed.

4.8 GoPro Camera

The GoPro camera cannot just be used as video source. The Recording box provides the possibility to transfer the GoPro video files automatically when the IR recording has been stopped.

Therefore, the USB-bridge cable must be attached as well as the mini-USB cable for the GoPro camera. Assure the GoPro camera is switched on.

The video data from GoPro is transferred in the following contexts:

Context	Function
Thermal imager record is saved on internal memory; USB-Drive is attached after recording is stopped.	Automatic copy of thermal imager record (RAW file) and GoPro data.
Record saved on external memory. Record was triggered by external switches. User is pressing the multi-purpose button.	GoPro Data is copied.

The following points need to be considered when using a GoPro camera:



- GoPro4 data transfer and video mode is supported by firmware version \geq v1.1.3.0
- GoPro data transfer relies on USB 2.0 data transfer rate. Large video files requires a long transfer time to USB Stick. To avoid automatic data transfer to USB drive, remove USB bridge cable from Recording box.
- Data transfer for GoPro3 works only one time. Recording box needs to be restarted for new data transfer.
- Data cannot be deleted from GoPro camera, this has to be done manually via the GoPro menu.

After the data transfer the charging mode on the GoPro camera is activated automatically. By interrupting the USB connection or switch off the Recording box the charging mode can be terminated. During the charging mode there is no GoPro video image available – if you switch on the VIS channel you will see this message:



Field number:

1. Universal Time Coordinated (HHMMSS.SS)
2. Status, (V=invalid data; A=Valid)
3. Latitude (ddmm.mmmm)
4. N or S (N=North / S=South)
5. Longitude (dddmm.mmmm)
6. E or W (E=East / W=West)
7. Speed over ground, (knots)
8. Track made good, (degrees true)
9. Date, (DDMMYY)
10. Magnetic Variation, (degrees)
11. E or W (East / West)
12. FAA mode indicator (A=Autonomous, D=Differential, E=Dead Reckoning, N=None)
13. Checksum



The accuracy of the provided coordinates relies on different aspects like weather conditions or satellite coverage. The sample rate is 5 Hz.

We recommend the NL-601US USB GPS receiver based on a u-blox 6 chipset.

http://www.navilock.de/produkte/G_60123/merkmale.html

If a compatible GPS is connected to the USB 2.0 port, and detected, and before valid GPS data are received, the message “**No GPS device attached**” is displayed.

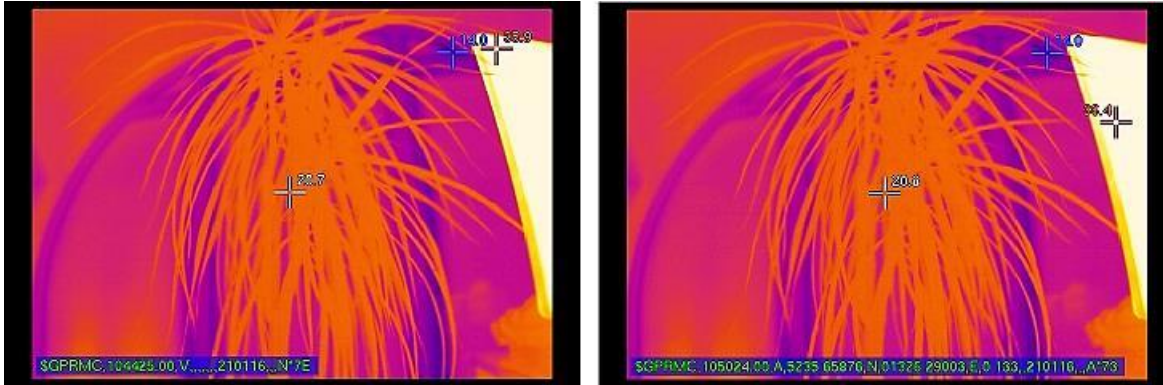

As soon as valid GPS “sentences” are received, the incomplete “RMC” frame is displayed at first (left figure): only UTC time and date are present.

When the fix has been done, the full RMC sentence is present.

4.10 Micro SD card

The Recording box is provided with a 16 GB micro SDHC card embedded in the computer. The card hosts a recovery system. In addition, the memory card can be used as internal memory for recordings.



The memory card is part of the operating system. Modifications and exchange can cause system damage!

SD card can be exchanged in case of damage or if additional internal memory for record is required.

For record, SD-cards should feature a write speed of at least 10 MByte/s for PI4xx and 22 MByte/s for PI640 (32Hz)/ PI4xx (80Hz). Frames get lost during record if write speed is not sufficient.

The default SD card which comes with the Recording box can only be used for recordings with a PI4xx (27Hz).

4.11 LED indicators

The Recording box is equipped with a total of 6 LED indicators:

- 5 status LEDs (L0-L4, above the multifunction button) see Figure 9: Controls and connections Recording box (3):

LED	Function	LED is ON, if:
L0	Power indicator	Recording box is powered via a power supply/ battery
L1	Flight-recorder service	Software basic functions are running
L2	PI camera status	Flight-recorder software and the thermal imager are running
L3	Video recording	IR data is being recorded in the internal memory (flashing)
L4	Data transfer	IR files are being copied to a USB-Stick (flashing)

Table 1: Recording box status information

- The LED under the left screw connector indicates that a GoPro video signal is available on the analog video output.

4.12 Using servo control

Two remote control inputs are available with the Recording box, see Figure 7: Controls and connections Recording box (1):

- Left socket allows to remotely control the start and stop of the recording
- Right socket allows to remotely toggle the analog CVBS video output between infrared image from PI camera, and visible image from the GoPro camera

4.12.1 Servo connector wiring

Left (black)	GND
Middle (red)	+5 V output
Right (yellow)	Signal input

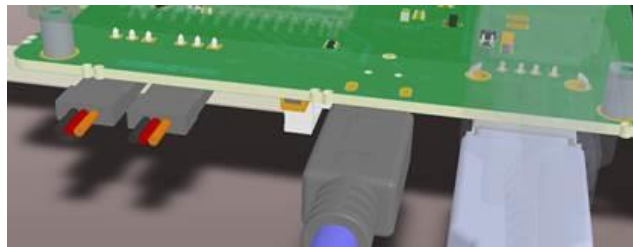

Figure 12: Servo-connector wiring (the two left connectors)



We recommend the use of Servo-connector (Uni, Graupner and JR) type.

4.13 Screw connectors interface

The Recording box is equipped with two screw block terminals:



Figure 13: Screw block terminals

Left connector

Four connections, from the left to the right:

GND | +5V output (100 mA max.) | GND | Video in (visible camera)



The analog NTSC Video IN can be used for alternative video cameras. In this case the GoPro camera is not supported.

Right connector

Four connections, from the left to the right:

S3 | S2 | GND | TVout

The external switches S2 and S3 are Low-active and must be tied to ground (a simple switch to ground is recommended).

S2: Start and Stop recording

S3: switch IR or visible cam (e.g. GoPro) to TVout connector

5 System Update and Recovery

The Recording box can be updated by the user. Beside of system updates also a system recovery can be done.

5.1 System updates

System updates can improve the amount of features or enhance the stability of the operating system.

- To update the system, the update files need to be copied to the root directory of an USB-Stick (FAT32 formatting).
- Start the box, wait until the box is up and the splash screen is visible.
- Plug your USB-Stick - the box should recognize the USB-stick indicated by changing state message
- The box should restart within 5 to 20 seconds. Your system has been updated.



- If the system is not restarting, check if the files are on the stick. Usually there are one update script and n update files.
- If the stick is not recognized, a restart of the box can help.
- Remove the update files from the stick before the stick is reused.

5.2 Recorder Software Update

The Recorder Software is responsible for the main functionality of the Recording box.

- To update the system, the update files need to be copied to the root directory of an USB-Stick (FAT32 formatting).
- Start the box, wait until the box is up and the splash screen is visible.
- Plug your USB-Stick - the box should recognize the USB-stick indicated by changing state message
- The box should restart within 5 to 20 seconds. Your system has been updated.



- If the system is not restarting, check if the files are on the stick. Usually there are one or two files, called “flightrecorder*.deb” or “libirimaget*.deb”.
- If the stick is not recognized, a restart can help.
- Remove the update files from the stick before the stick is reused.

5.3 System Recovery

For a system recovery the SD-card needs to be removed from the Recording box.

- Remove the cover which protects the SD-card. **Unscrew only the central screw (of three).**
- Remove the SD-card.
- Download the new SD-card image (ask your local distributor for a download link).
- Plug your SD-card to a card reader. It is recommended to use a USB 3.0 card reader.
- Download the software **Win32 Disk Imager** (free tool for writing of images to SD cards) from here: <https://sourceforge.net/projects/win32diskimager/>.
- Start the Win32 Disk Imager software and write the downloaded image to the SD card.
- Unplug all devices and cables from the Recording box, assure the box is not powered.
- Plug the SD card to the Recording box and set the **Boot switch** on the left position. The switch is located inside the housing above the status LEDs and can be reached through a vent in the housing. Use a thin tweezer or a thin screw driver. Be careful not to damage the electronics.
- Plug monitor, power, and an USB keyboard to the box and wait until the blue screen offering a **system reset**.
- Confirm with **Yes** and wait until the reset has been finished. Confirm with **Enter** and wait for the system shutdown.
- The system should be recovered now.

6 Calibration files and Time settings

The PI cameras are not only infrared imagers, they are mainly thermal measuring devices and so they need calibration files to work properly.

These calibration files are specific to each camera and lens and are installed at factory on the Recording box, but after a recovery it is necessary to install them again in the system.

6.1 Installing the calibration files through Internet

Connect the Ethernet RJ45 port to a network connected to Internet, if there is a DHCP server on the local network, the IP communication setup will be done automatically. Connect the PI camera to an USB 3.0 port.

The software identifies the PI camera serial number and downloads automatically the right calibration files from the internet. Then the recorder software is starting automatically and you should see the IR image on your control monitor.

6.2 Installing the calibration files with an USB flash memory

Two options are possible:

1/ Copy the directory named "Califiles SNxxxxxxx" from the PIConnect CD-ROM provided with the PI camera to an USB stick manually (where SNxxxxxxx is the serial number of the connected PI camera).

2/ Use PIconnect software to copy automatically the correct calibration files corresponding to the PI camera currently connected to this PC: Menu “**Tools/ Extended/ Config Recording box**”, check “**Copy calibration data**” and select the USB flash memory where you want to copy these files.

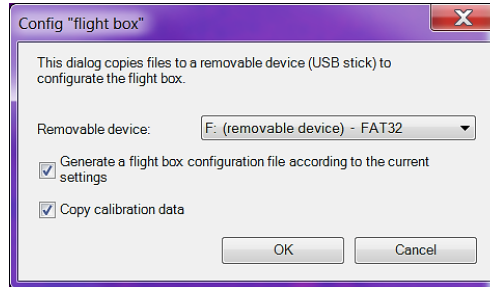

Press OK.

Plug this USB stick to the Recording box, connect the PI camera SNxxxxxxx to an USB 3.0 port (blue) and power ON the system.

The calibration files are automatically loaded to the system and the infrared image is displayed showing that the calibration files are in use.

This installation process has to be done only once per camera running with this Recording box.

6.3 Time settings

For automatic time synchronization, the Recording box needs to be connected to a local network with internet access.



Reassure the local network is granting access to internet for loading calibration files and synchronizing time.

Usually company networks are protected, especially for devices which are not part of a company domain.

7 Backup battery replacement

The Recording box is equipped with a Real Time Clock supplied by a 3V lithium battery (CR 1632). The battery can be exchanged if necessary.

Unscrew the four screws on the bottom of the Recording box and remove the cover. Remove the battery from mount carefully using a thin screw driver. Replace it only with a **3 V lithium battery CR 1632** or equivalent.

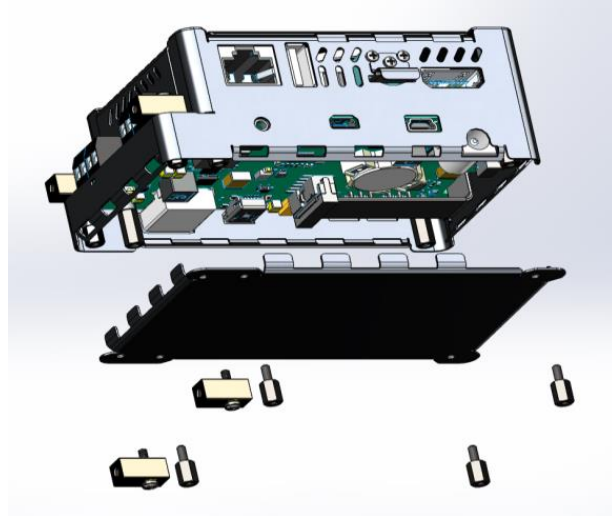
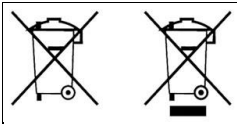

Figure 14: Open view for the localization of the RTC battery

8 Basics of Infrared Thermometry

Depending on the temperature each object emits a certain amount of infrared radiation. A change in the temperature of the object is accompanied by a change in the intensity of the radiation.

Searching for new optical material William Herschel by chance found the infrared radiation in 1800.

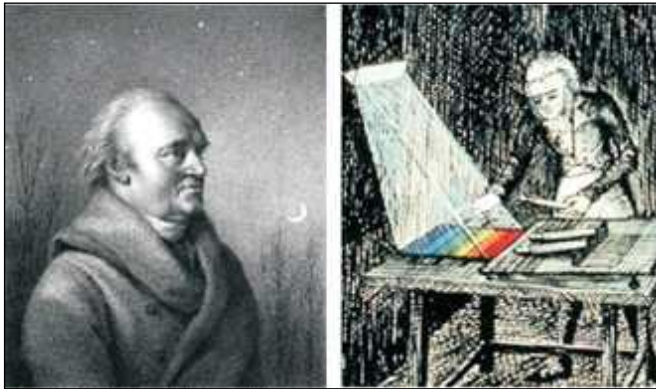

Figure 15: William Herschel (1738-1822)

He blackened the peak of a sensitive mercury thermometer. This thermometer, a glass prism that led sun rays onto a table made his measuring arrangement. With this, he tested the heating of different colors of the spectrum. Slowly moving the peak of the blackened thermometer through the colors of the spectrum, he noticed the increasing temperature from violet to red. The temperature rose even more in the area behind the red end of the spectrum. Finally he found the maximum temperature far behind the red area.

Nowadays this area is called “infrared wavelength area”.

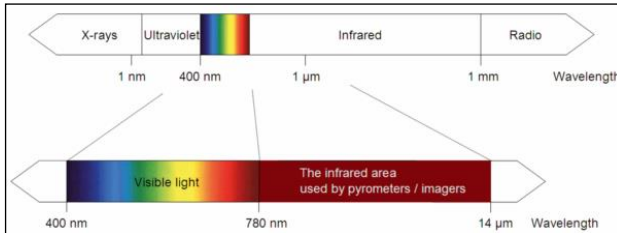

Figure 16: The electromagnetic spectrum and the area used for temperature measurement

For the measurement of “thermal radiation” infrared thermometry uses a wavelength ranging between 1μ and 20μ . The intensity of the emitted radiation depends on the material. This material constant is described with the help of the emissivity which is a known value for most materials (see enclosed table emissivity).

Infrared thermometers are optoelectronic sensors. They calculate the surface temperature on the basis of the emitted infrared radiation from an object. The most important feature of infrared thermometers is that they enable the user to measure objects contactless. Consequently, these products help to measure the temperature of inaccessible or moving objects without difficulties.

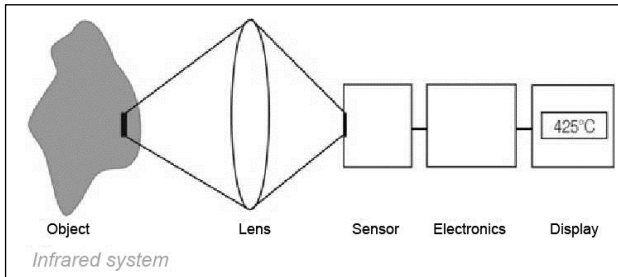

Figure 17: Main principle of noncontact thermometry

Infrared thermometers basically consist of the following components:

- Lens
- Spectral filter
- Detector
- Electronics(amplifier/ linearization/ signal processing)

The specifications of the lens decisively determine the optical path of the infrared thermometer, which is characterized by the ratio Distance to Spot size. The spectral filter selects the wavelength range, which is relevant for the temperature measurement. The detector in cooperation with the processing electronics transforms the emitted infrared radiation into electrical signals.

The advantages of noncontact thermometry are clear - it supports:

- temperature measurements of moving or overheated objects and of objects in hazardous surroundings
- very fast response and exposure times
- measurement without inter-reaction, no influence on the measuring object
- non-destructive measurement
- long lasting measurement, no mechanical wear

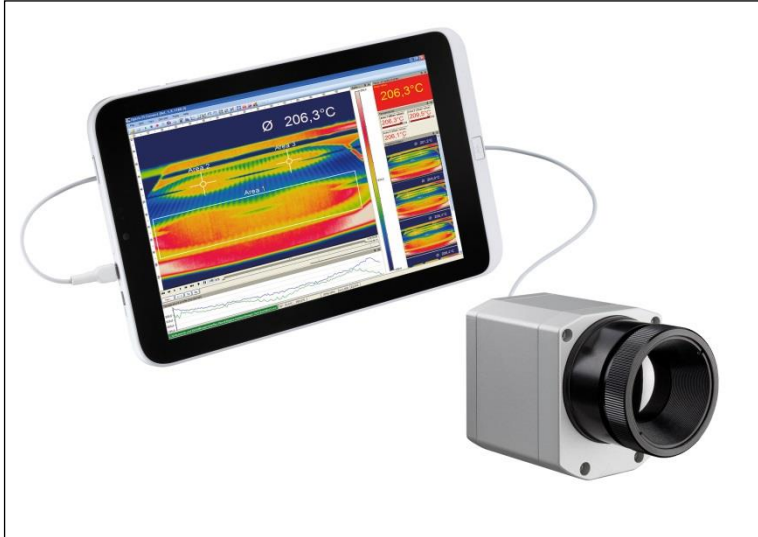
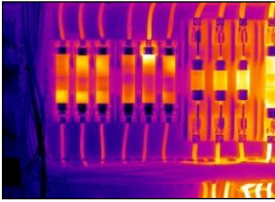
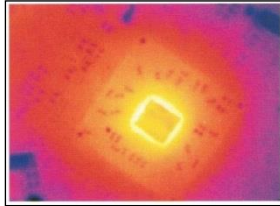

Figure 18: Contactless thermometry

Application fields:



Monitoring of electronic cabinets



R&D of electronics

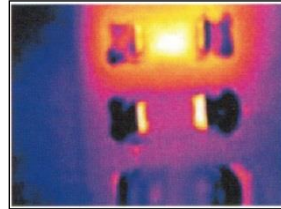

R&D of electronic parts

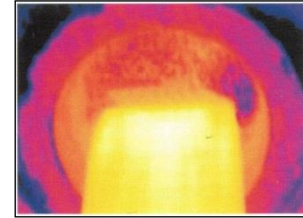

Process control extruding plastic parts

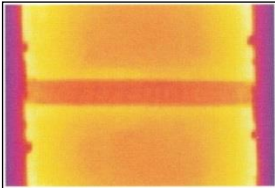

Process control manufacturing solar modules

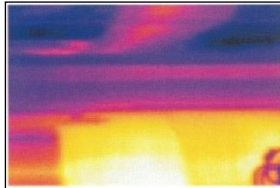

Process control at calendering

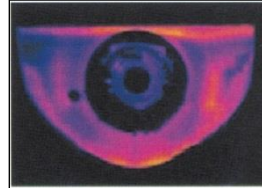

R&D of mechanical parts

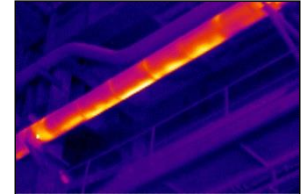

Monitoring of cables

Emissivity:

Definition: The intensity of infrared radiation, which is emitted by each body, depends on the temperature as well as on the radiation features of the surface material of the measuring object. The emissivity (ϵ – Epsilon) is used as a material constant factor to describe the ability of the body to emit infrared energy. It can range between 0 and 100 %. A “blackbody” is the ideal radiation source with an emissivity of 1.0 whereas a mirror shows an emissivity of 0.1. If the emissivity chosen is too high, the infrared thermometer may display a temperature value which is much lower than the real temperature – assuming the measuring object is warmer than its surroundings. A low emissivity (reflective surfaces) carries the risk of inaccurate measuring results by interfering infrared radiation emitted by background objects (flames, heating systems, chamottes). To minimize measuring errors in such cases, the handling should be performed very carefully and the unit should be protected against reflecting radiation sources.

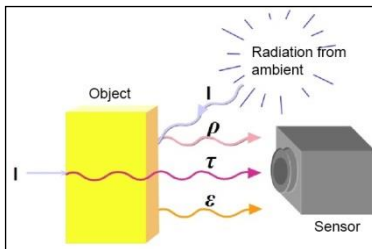

- I Radiation
- ϵ Emission
- ρ Reflection
- τ Transmission

$$\epsilon + \rho + \tau = 1$$

Figure 19: Capability of an object to emit radiation

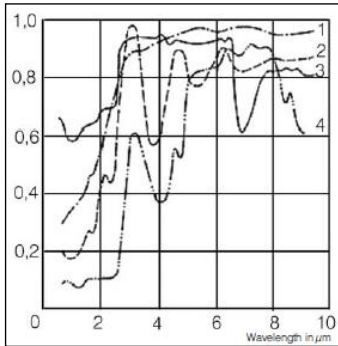

Figure 20: Spectral emissivity of several materials: 1 Enamel, 2 Plaster, 3 Concrete, 4 Chamotte

9 CE Conformity

EG-Konformitätserklärung EU Declaration of Conformity



Wir / We

Optris GmbH
Ferdinand Buisson Str. 14
D-13127 Berlin

erklären in alleiniger Verantwortung, dass
declare on our own responsibility that

die Produktserie optris PI
the product group optris PI

den Anforderungen der EMV-Richtlinie 2014/30/EU und der Niederspannungsrichtlinie 2014/35/EU
meets the provisions of the EMC Directive 2014/30/EU and the Low Voltage Directive 2014/35/EU.

Angewendte harmonisierte Normen:
Applied harmonized standards:

EMV Anforderungen / EMC General Requirements:
EN 61326-1:2013 (Grundlegende Prüfanforderungen / Basic requirements)
EN 61326-2-3:2013

Gerätesicherheit von Messgeräten / Safety of measurement devices:

EN 61010-1:2010
EN 60825-1:2015 (Lasersicherheit / Laser safety)

Dieses Produkt erfüllt die Vorschriften der Richtlinie 2011/65/EU (RoHS) des Europäischen
Parlaments und des Rates vom 8. Juni 2011 zur Beschränkung der Verwendung bestimmter
gefährlicher Stoffe in Elektro- und Elektronikgeräten.
This product is in conformity with Directive 2011/65/EU (RoHS) of the European Parliament and of
the Council of 8 June 2011 on the restriction of the use of certain hazardous substances in
electrical and electronic equipment.

Berlin, 04.11.2015

Ort, Datum / place, date

Dr. Ulrich Kientz
Geschäftsführer / General Manager

